



**Thank you for purchasing CellGem®
Please read this handbook carefully
before operating the chip**

CONTENTS

I	Introduction, Principle, Application, Precautions	P1
II	Preparation of experiment materials and cell samples	P6
III	Procedure	P7
	Part I: Cell Capture	P7
	Part II: Cell Culture	P11
	Part III: Cell Harvest	P12
IV	Q&A	P13

I INTRODUCTION | What's In The Box?

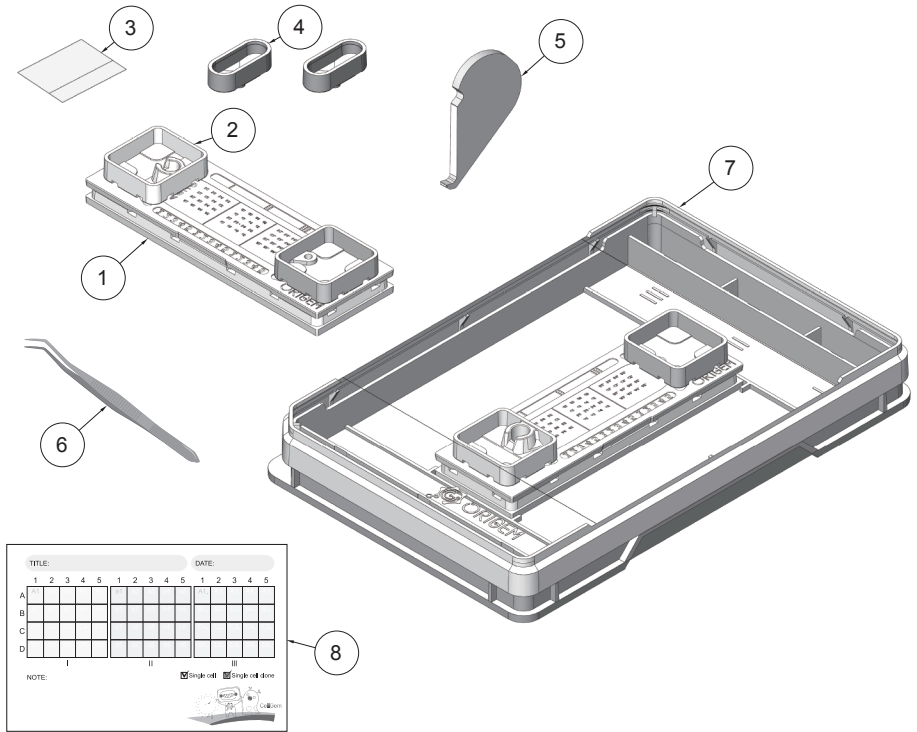

- ① CellGem® chip
(2 reservoirs are connected already)
- ② Reservoirs
- ③ Sealing tape
- ④ Cell culture reservoirs
- ⑤ Disassembly tool
- ⑥ Tweezer
- ⑦ Chip carrier
- ⑧ Card for recording data

REMINDERS

- ★ Please store in a cool, dry place, away from heat and direct sunlight.
- ★ All components are sterile. Please Don't use the chip if any damage appears.
- ★ Open the package **right before using it ONLY.**

THE CellGem® CHIP

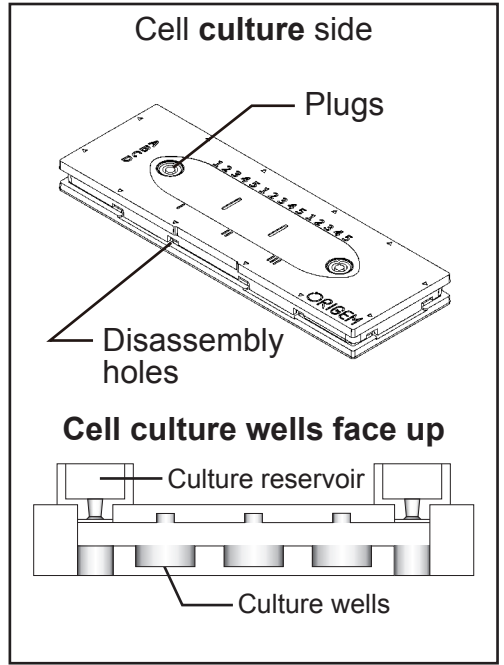
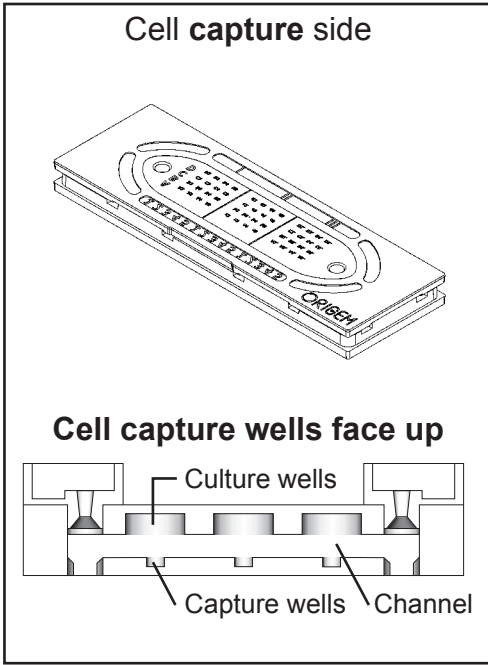

The CellGem® chip consists of 3 different layers shown in below.

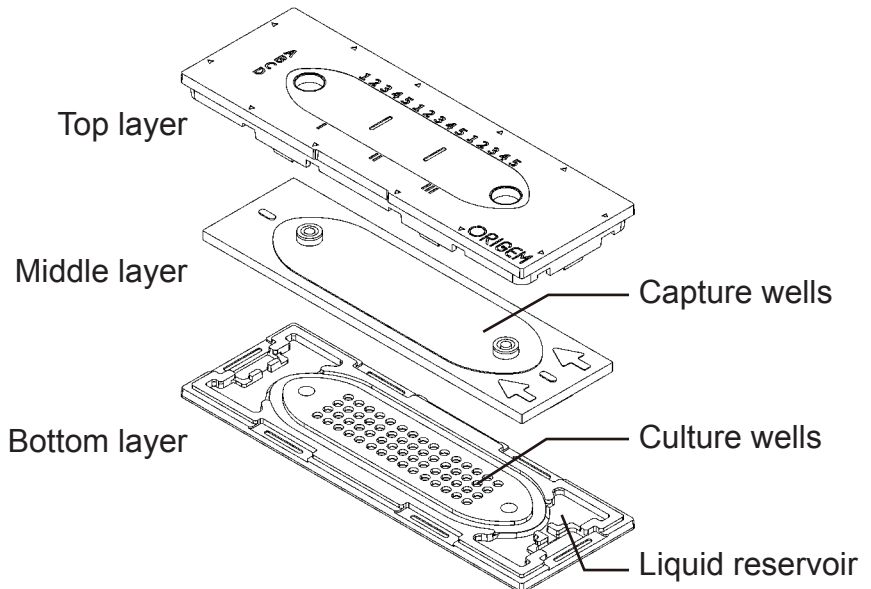

MARKERS ON THE CHIP

The culture wells are divided into 3 regions by dividing lines. Each region contains $5 \times 4 = 20$ wells, and a total of 60 wells.

△ Markers are used for chip disassembly during the harvest step.

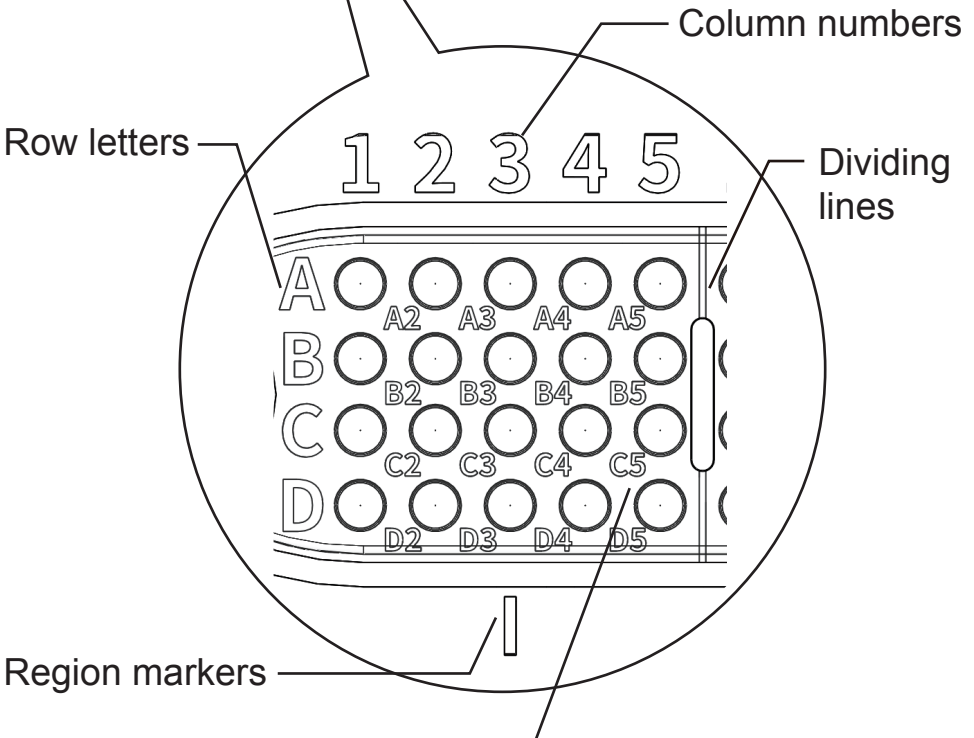
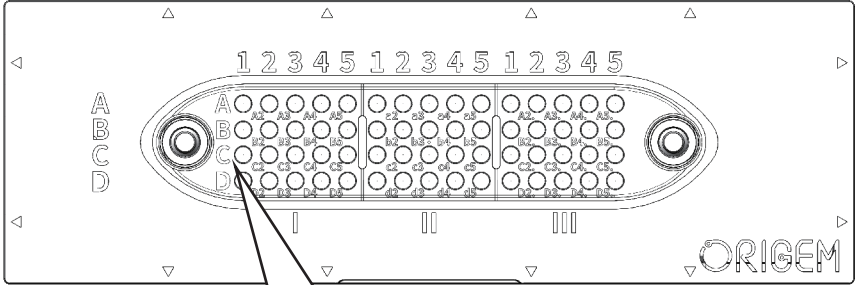

Individual culture well markers
(The 1st column of each region lacks individual well markers)

PRINCIPLE

CellGem® uses micropores of different sizes to capture single cells and drop them down to form single-cell colony.

Capture single cells with the micropores.

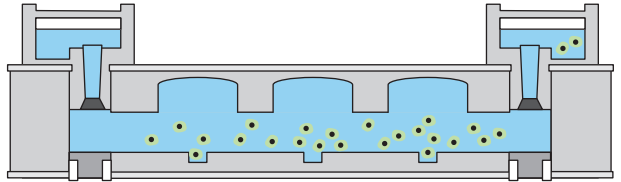

Flip CellGem® to drop captured single cells into culture wells.

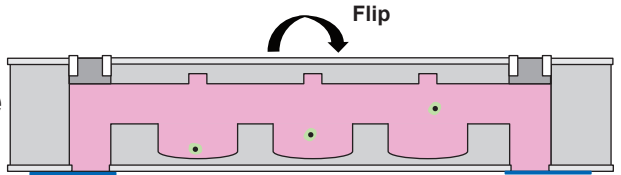

Culture single cells.

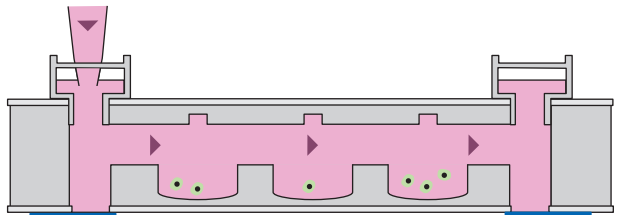

APPLICATION

Stable cell line clone, Cell heterogeneity research, Cell immunotherapy, Cancer research, Drug screening, Monoclonal antibody production.

PRECAUTION

► Pipetting Method

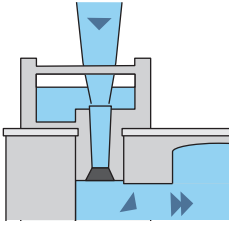

Dispensing

Insert tip into inlet port

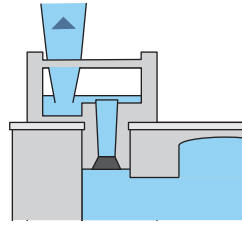

Aspirating

Aspirate **around** the inlet port

► Avoid Bubbles

Take care to avoid bubbles in the pipet tip and make sure reservoir inlets are filled with liquid.

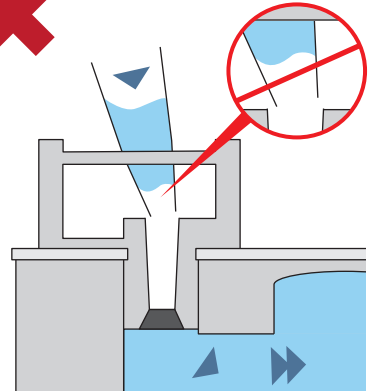
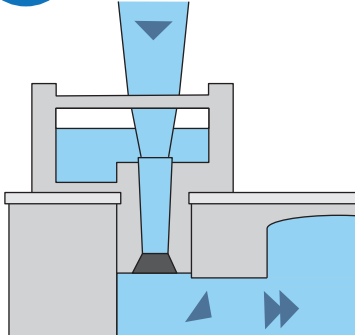

► Cell morphologies will affect capture efficiency.

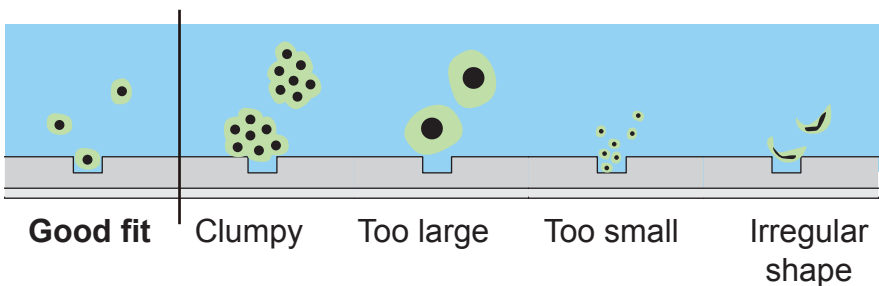

II PREPARATION OF EXPERIMENTS MATERIALS AND CELL SAMPLES

► EXPERIMENTS MATERIALS

1. Priming solution:30~35% ethanol (37°C)
2. Pipet and P1000 tips
3. 5 ml syringe
4. Tweezer
5. Inverted microscope

► CELL SAMPLES (Preventing cell clusters is key)

Using similar methods as preparing cell samples for flow cytometry.

► Recommended solutions for cell resuspension

- 1X PBS
- Low serum/serum-free medium
- FACS sorting buffer
- Cell dissociation buffer

► A recommended concentration of cell sample is 1×10^6 cells/ml.

► Product specifications

CellGem® Specs	Suitable Cell Size (Diameter)	Cell line
S	8-12 μm	Cho-k1, AA8, Jurkat, SP2/0-Ag14
M	11-17 μm	A-549, L929, Eh7a
L	14-25 μm	

III PROCEDURE (3 MAJOR STEPS)

Cell capture → Cell culture → Cell harvest

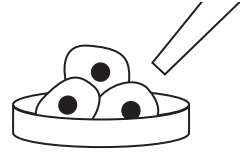

Part I : Capture

CELL CAPTURE (Cell capture side)

Pre-rinse

Slowly inject 1 ml of priming solution (30~35% ethanol) into either inlet and keep it still for 10-30 seconds.

Inject priming solution faster 3 times to drive out bubbles and ensure the entire chip is filled with solution.

(See detailed operation in the video).

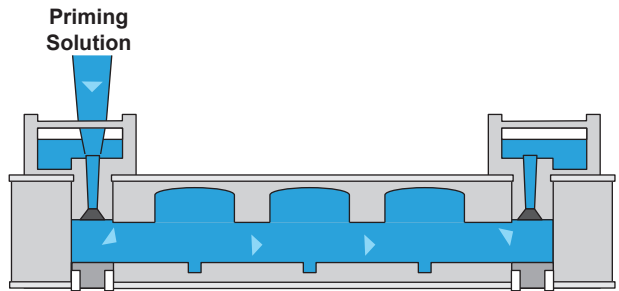

Inject 1 mL of PBS into the chip 3 times to replace priming solution completely.

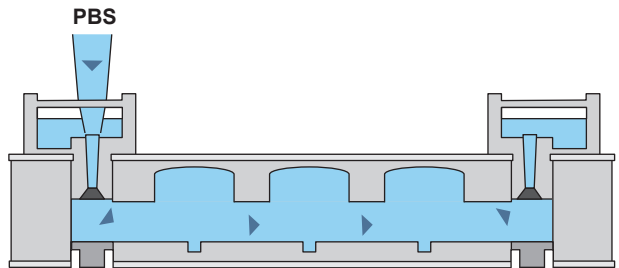

★ No matter what you inject, please make sure that free bubbles are necessary at the very tip of the pipet or syringe. Air bubbles can significantly affect the performance of the chip.

Cell loading and washing

3

Inject 600 μL of cell suspension into the chip (recommended concentration: 1×10^6 cells/ml). Wait for 3 minutes, cells will settle to the capture wells.

★ Make sure to fully resuspend cells before injecting them into the chip.

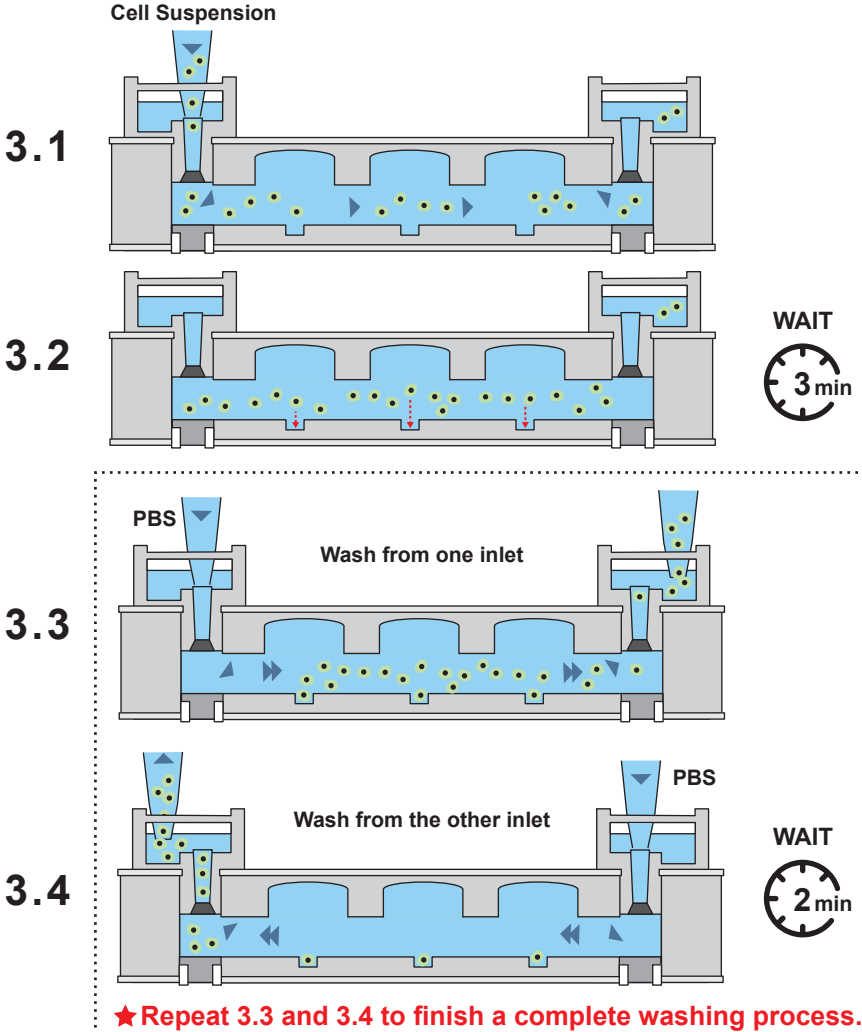

★ Repeat 3.3 and 3.4 to finish a complete washing process.

★ Finishing all the procedures is “ONE” complete cell loading and washing process.

★ “TWO” complete processes are recommended to get better results.

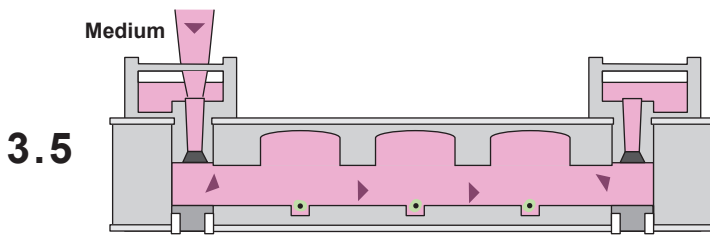

3.5

Replace the PBS with 1mL of culture medium.

4

Here is the procedure to wash the channel by a syringe.

- 1 Insert the syringe with 5 ml of PBS into the reservoir, and inject PBS with a speed of 1 ml/sec. At the same time, use a pipet or suction to aspirate out the wash solution.
- 2 When the syringe is nearly depleted (with 0.5 ml PBS left), add left 0.5 ml PBS into the reservoir to fully cover the inlet ports.

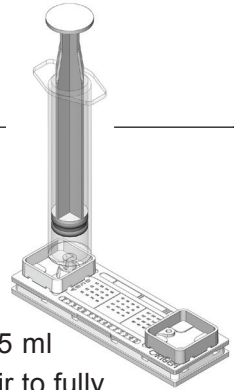

★ This prevents air from being introduced into the chip during removing the syringe.

- 3 Flush the other reservoir with the above steps. After flushing both reservoirs, wait for 2 minutes.
- 4 Repeat 1-3 again, and make sure that no non-captured cells exist.

★ There is no limitation on how many times you can wash the chip. Recommend that rinse at least two times to fully remove non-captured cells.

- 5 Inspect the captured cells under a microscope. If capture efficiency is not good enough, you can load cells and flush them again.

Seal and Flip

Fully aspirate all the remaining liquid in the reservoirs, then remove the reservoirs from the chip. Wipe off any liquid on the surface of the chip, then fill up the inlets with the medium. Seal the inlets with the sealing tape.

★ **Stickers should not cover/overlap the culture well, or observation will be affected.**

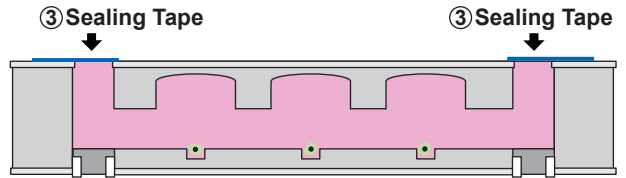
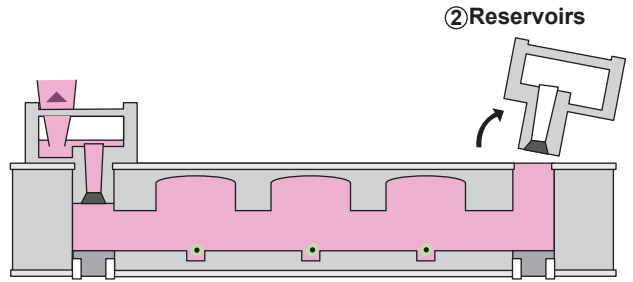

(This is a pressure-sensitive tape and **applying pressure is necessary to seal the inlets**).

Flip the chip over 180° and keep it still for 30 minutes to settle cells naturally into the culture wells.

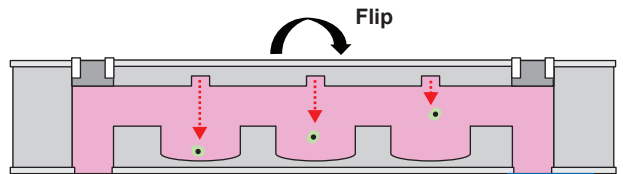

Add 2 mL of 1X PBS into reservoirs in the edge of the carrier to maintain culture humidity, and cover with lid. Record single cell locations in recording cards, and place the carrier with chip into a cell culture incubator.

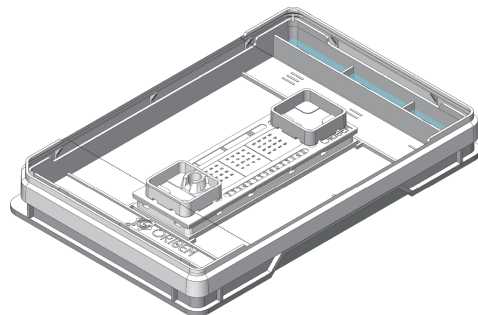

CELL CULTURE (Cell culture side)

Install cell culture reservoirs for changing medium

1

After culturing for 1-2 days (Cells are fully attached), install cell culture reservoirs ④.

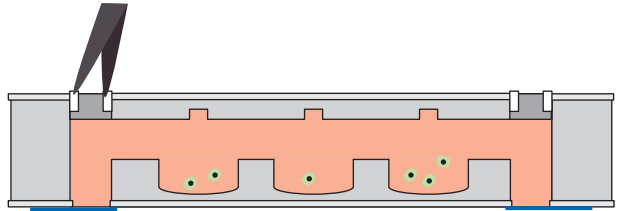

2

Use tweezers ⑥ to remove plugs. Insert the tweezer vertically into the inlet and **apply pressure to break the weak attachment before pulling out the plug.**

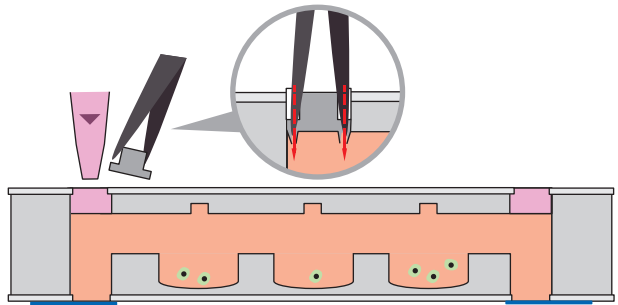

★ **don't puncture the bottom sealing tape ③ by inserting the tweezer too deep.**

3

Install cell culture reservoirs ④ onto the chip. Slowly inject fresh medium into the chip.

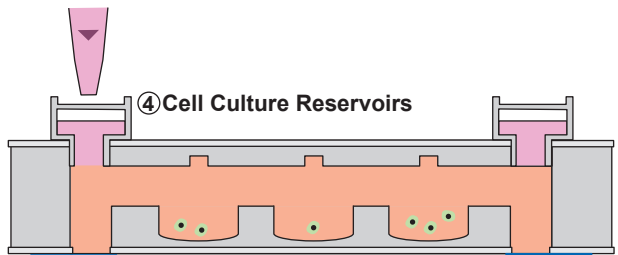

4

Refresh medium every 2-3 days. Adding fresh medium into one of the reservoirs will slowly refresh the medium inside the chip via hydrostatic pressure difference.

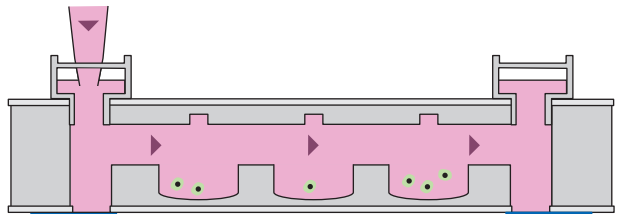

★ **If there is any small bubble inside the chip, please slowly inject medium into the chip to remove the bubbles.**
 ★ **If there is no hydrostatic pressure difference, please remove any bubble around the inlet ports and add more medium into the reservoir.**

CELL HARVEST

After culturing for 7-14 days, disassemble the chip for harvesting cells.
(Exact culture time depends on cell type)

1

Remove the cell culture reservoirs.

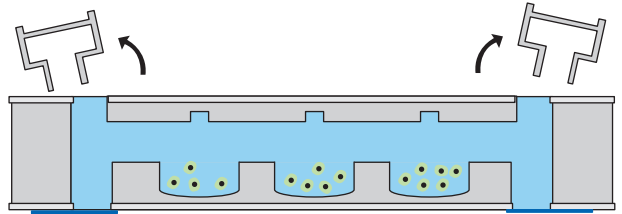

2

Insert the disassembly tool into the disassembly holes on the sides of the chip (see page 3 location markers). **Rotate** the disassembly tool to pry open the chip.

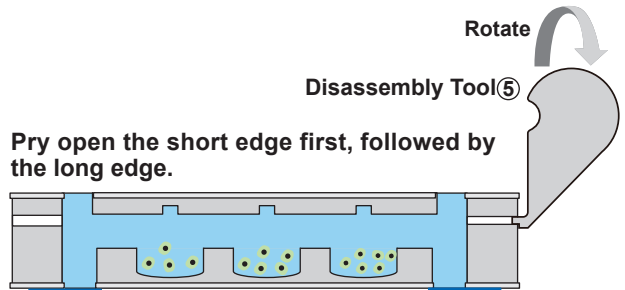

3

After opening the chip, remove the top (hard) cover, slightly tilt the chip and softly peel up the middle soft layer. Add 1.5 μL of trypsin into each culture well by inspecting the cultured cells, or by recording cards that record which wells cultured cells exist in.

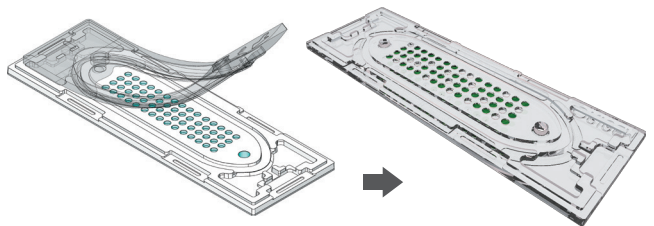

4

Use a 2 μL pipet to aspirate the cells from the culture wells and transfer them to a larger culture plate. **The working volume of each culture well is 1.5 μL .**

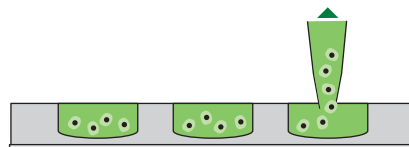

IV Q&A

1. Q: An air bubble was trapped in the chip during the priming step. How do I get rid of it?

A: Fully aspirate the priming solution from the chip, then rapidly inject the priming solution back into the chip. This helps to remove bubbles.

2. Q: Is there a contamination risk of using sealing tape to seal the chip inlets?

A: The sealing tape used in the kit is tested and certified to be sterile. It's safe to use with cell culture.

3. Q: After flipping over the chip, how do the captured cells accurately land in their corresponding culture wells?

A: The capture wells are specifically designed to ensure that each captured single cell will only land in its designated culture well after flipping the chip. However, the chip can only be flipped over once. Users should avoid flipping it over again after the single cell transfer step.

4. Q: What are the advantages of CellGem[®] compared to other single cell separation products in the market?

A: CellGem[®] does not require complex instrumentation and is easy to use. It also has high single-cell capture efficiency, high single-cell growth rate, easy to identify single cells, and consumes minimal cell culture medium.

5. Q: Following the previous question, what do you mean by high single cell growth rate? In theory, single cells don't grow into colonies efficiently, why is this?

A: Because all the cells inside the CellGem[®] chip share the same pool of culture medium, and also share secreted growth factors between each other. Each single cell still owns its isolated growth space at the same time. (Depend on cell type.)

6. Q: Why is my cell capture efficiency low? How do I increase single cell capture efficiency?

- A: 1. If your cells are clumpy, then they cannot be efficiently captured by the capture wells. We recommend trying a cell dissociation reagent that's compatible with your cells (ex. Accumax, sorting buffer.)
2. There may be excess bubbles in the chip, affecting cell capture efficiency. We recommend trying the bubble removal method in page 8 of the handbook (Page 7)
3. You may have selected a capture well size that's not a good fit for your cell of interest. We recommend measuring the size (diameter) of your cells and selecting the product with the corresponding suitable capture well size (Page 6)
4. Your cell concentration may be too low. Cell concentration of 1×10^6 cell/ml or above is recommended.
5. Loading cells multiple times to increase capture efficiency.

7. Q: If there are cells existing in the channel, will it affect the monoclonality of my single cell-derived colony? If so, how do I perform the subsequent cell harvesting steps to avoid contaminating my single cell colonies?

A: Cells exist in the channel do have the potential of contaminating your single cell colonies and affecting monoclonality. So, It's important to ensure that the washing step is done well to remove excess cells from the chip.

If residual cells still exist in the channel, do not directly inject trypsin into the chip before harvesting stage. Instead, disassemble the chip while the cells are still attached, then individually add trypsin to each culture well to detach the cells. **The working volume of each culture well is 1.5 μ L.**



ORIGEM

OriGem Biotech Inc.

🌐 www.origembiotech.com

✉ info@origembiotech.com